

Capacity: 1/8", through 5"

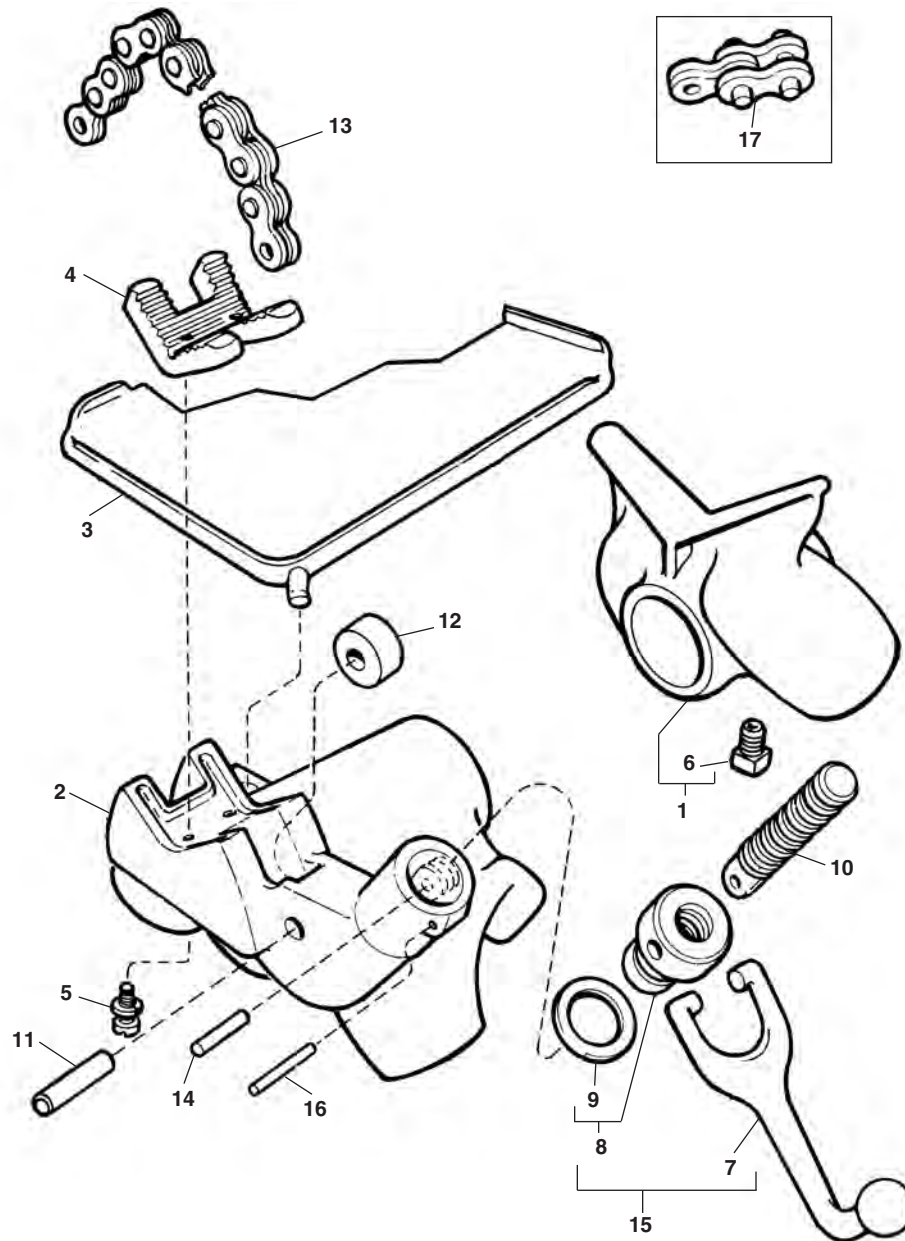

**NOTE: Order parts by Catalog Number only.  
DO NOT order by Reference Number.**

Ref. No.	Catalog No.	Description	Ref. No.	Catalog No.	Description
—	40165	560 Stand Chain Vise	9	41025	Friction Ring
1	40850	Rear Support with Set Screw	10	41065	Chain Screw
2	41165	Base	11	41035	Roll Pin
3	40845	Tool Tray	12	40990	Roll
4	41020	Jaw	13	72092	Chain Assembly
	41280	Jaw for Plastic Pipe	14	41040	Chain Screw Pin
	40222	Jaw for Coated Pipe	15	41050	Handle, Swivel Nut & Friction Ring Assembly
5	40785	Jaw Screw & Washer (2)	16	31650	Nut Locking Pin
6	40855	Set Screw	17	68625	Link
7	41015	Handle			
8	41060	Swivel Nut with Friction Ring			